



## LIGHT BARS 1 - CASE

Stackable flight case for various 1 m lightbar models

Référence: B03307

**890,00 € inc. VAT**



- Stackable flight case for various 1 m lightbar models
- The flight case can be fitted with different divider sets to carry different models of 1 m long light bars.
- Separator sets are sold separately, see related products:
  - DIVIDER SET B: used to transport 12x BTI-LIGHTSTRIKE IP66
  - (separator sets for other light bars will follow soon)
- Separate compartment for cables and omega hooks/supports
- High quality materials have been used to ensure a solid and reliable product:
  - Robust 9 mm plywood with black HEXA finish
  - Reinforced corners
  - 2 recessed handles on all sides
  - 4 x 100 mm soft rubber castors, 2 of which have brakes
  - Equipped with sturdy butterfly clasps
- Specially-adapted protective foam interior for optimum impact protection
- Standard truck size: 120 x 60 x 60 cm (height incl. wheels = 74 cm)
- Weight: 55 kg

## Caractéristiques

<b>Brand</b>	JVcase
--------------	--------

## Références compatibles



**BTI-BEAMBAR18**

**1190,00 €  
inc. VAT**

Réf: B05576



**BTI-LIGHTSTRIKE  
IP66**

**1090,00 €  
inc. VAT**

Réf: B04719



**BTX-LIGHTSTRIKE**

**759,00 € inc.  
VAT**

Réf: B04718



**LIGHT BARS 1 -  
DIVIDER SET A**

**69,00 € inc.  
VAT**

Réf: B03310



**LIGHT BARS 1 -  
DIVIDER SET B**

**59,00 € inc.  
VAT**

Réf: B03311

## Galerie photos











# HEXA SURFACE

# LIGHT BARS 1 - CASE

External Dims.: 120 x 60 x 60 cm

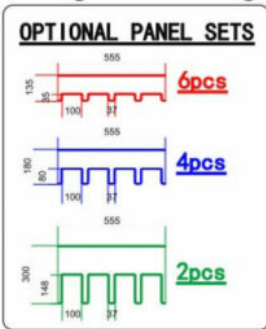
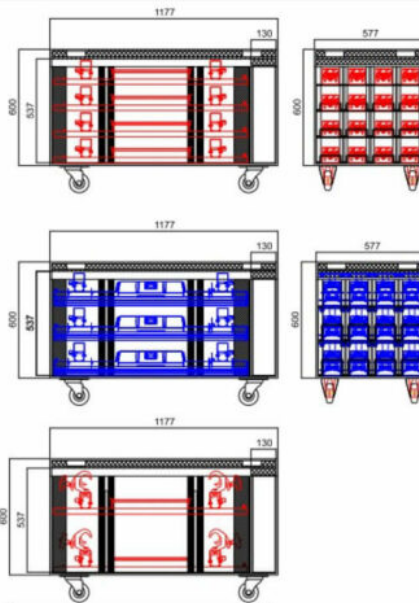
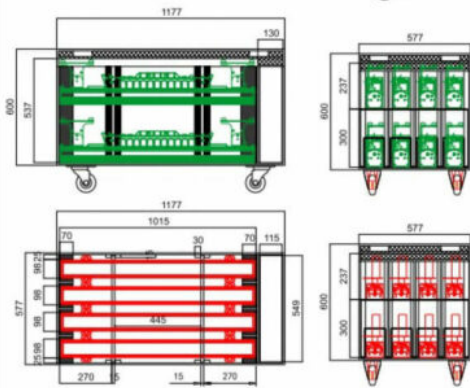
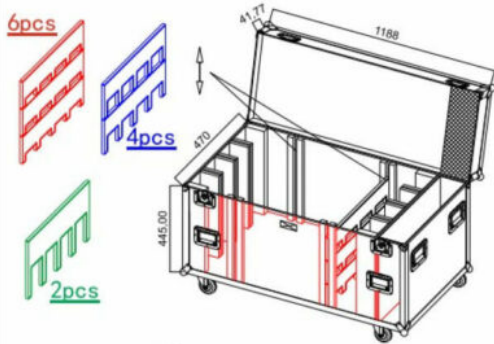

## OPTIONAL PANEL SETS

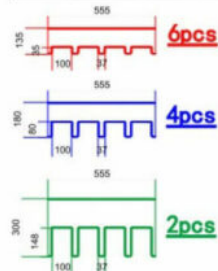

## DIFFERENT BAR MODELS

### BTI-LIGHTSTRIKE IP66

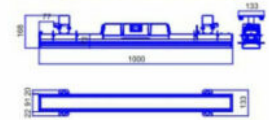

### BTI-BEAMBAR18

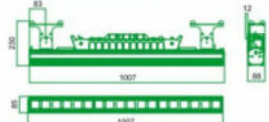

### BTX-LIGHTSTRIKE

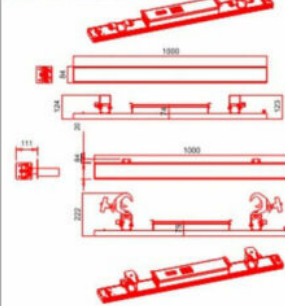

**JV** **Case**  
[WWW.JVCASE.COM](http://WWW.JVCASE.COM)